

8) Prior to washing the walls near the hand dryer with a hose or high pressure pump, it is highly recommended to uninstall the hand dryer from the wall.

9) Proper training of the maintenance staff is very essential for ensuring proper functioning and long service life of the hand dryer.

Precautions: 

- 1) Do not use abrasive cleaning chemicals to clean the hand dryer outer cover.
- 2) Before touching the hand dryer, please make sure the plug is removed from the power supply socket.
- 3) Do not use the hand dryer for any other purpose than drying hands.
- 4) If there is any burning smell or smoke from the hand dryer, immediately switch off the power supply. In case of such an incident, only qualified electricians should handle the unit.
- 5) While in operation, do not block the air inlet / outlet of the hand dryer. This can cause the hand dryer to overheat.
- 6) Only a qualified technician should repair the hand dryer. If you need to replace any spare part, please do so only in accordance with this manual.

askon
askon hygiene products pvt. ltd.

Email : info@askonhygiene.com
www.askonhygiene.com

**INSTALLATION AND INSTRUCTION
MANUAL FOR AS 25-IR Series
HAND DRYERS**

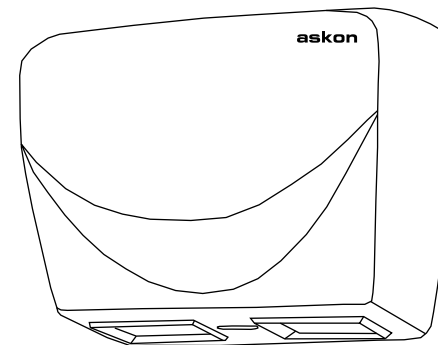

MODELS

- 1) AS 25-IR (SB)
- 2) AS 25-IR (SM)
- 3) AS 25-IR (W)

Note to Installer : Please give this manual to the end user after installation for better performance and maintenance of hand dryers.

INDEX

| Sr. No. | Description | Page No. |
|---------|--|----------|
| 1 | Important Safeguards | 3 |
| 2 | Recommended Mounting Height | 4 |
| 3 | Installation Instruction | 4 |
| 4 | How to use the hand dryer | 5 |
| 5 | How to remove the hand dryer outer cover | 5 |
| 6 | How to replace the sensor module | 6 |
| 7 | How to replace the PCB | 8 |
| 8 | Explanation of wire connections | 10 |
| 9 | Maintenance Instructions | 11 |
| 10 | Precautions | 12 |

Maintenance instructions:

The hand dryer may collect dust that is present in the air. It should be cleaned periodically to maintain it in good operating condition. Cleaning the hand dryer once a year is recommended.

To clean the hand dryer:

- 1) Switch OFF the power supply and remove the power supply cord.
- 2) If required remove the outer cover as described earlier.
- 3) Use a soft-medium bristle brush to clean the dust and debris from the air intake slots located on the bottom of the outer cover and the back plate of the hand dryer.
- 4) Check the heating coil box for accumulation of dust. Gently remove the dust with a brush taking care not to damage the heating coil and components like the thermal cut-off and thermal fuse. Do not use excessive force.
- 5) If required an air blower can be used to gently blow off the dust.
- 6) After cleaning, fit the outer cover back in its place and install the hand dryer.
- 7) Hand dryer cover should be cleaned with a moist  cloth preferably followed by a dry cloth. Water should not drip from the cloth or it can damage the internal electronic components of the hand dryer.

Explanation of wire connections:

Do not remove any wires from the three pole connectors (Refer Fig. 7). To replace the PCB, do not touch the wire connections on the 'B' side of terminal connector which are already made by the manufacturer.

Please connect the ground wire (green) from the power supply cord to the earthing terminal on the PCB stand. It is of utmost importance for the safety of the users. 

'A' Side

- A1** - Red wire from Power Supply Cord
- A2** - Black wire from Power Supply Cord
- A3** - Black wire from three pole connector on the right
- A4** - Yellow wire from the three pole connector on the right

'B' Side

- B1** - Red wire from the PCB
- B2, B3** - Two black wires from the PCB (these two positions are interchangeable)
- B4** - Yellow wire from PCB

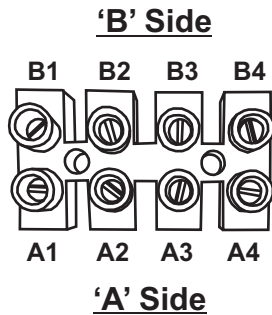



Fig. 8

(Terminal Connector)



Important Safeguards













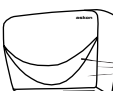

(For your safety, please follow the instructions below)

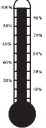
Read these Important Safeguards thoroughly before using the hand dryers and follow the precautions carefully.

 **Warning** Ignoring these symbols may cause system to malfunction or not install correctly

The items of observation are classified and described as below:

| | | | |
|---|---------------------|---|---|
|  | Absolutely "DO NOT" |  | Do not install the product in high humidity area such as a shower area or sauna |
|  | Do not disassemble | | |

|  Warning | | | |
|--|---|---|---|
|  | Never splash water on the hand dryers. <i>Hand dryer is an electrical appliance. This may cause product malfunction.</i> |  |  |
| | Do not strike or kick the hand dryer. <i>This may cause product malfunction.</i> |  |  |
| | Do not use the hand dryer at temperatures exceeding what local codes allow. <i>This may cause product malfunction.</i> |  |  |
|  | Do not install the hand dryers in a room with high humidity such as shower area or sauna. <i>This may cause product malfunction.</i> |  |  |
|  | Never attempt to disassemble, reassemble or modify the hand dryer unless you are a trained electrician. <i>This may cause product malfunction or electric shock.</i> |  |  |

Recommended Mounting Height:

| Recommended Mounting Height from floor to the bottom of the hand dryer | Inches |
|--|--------|
| Men's Washroom | 46 |
| Women's Washroom | 44 |
| Handicap Washroom | 37 |

Installation Instructions:

- 1) Use the above table to determine suitable mounting height.
- 2) Select a mounting location such that there is no reflective surface or object directly underneath the hand dryer. The minimum distance from the bottom of the hand dryer to any surface should be 18 inches. When two or more hand dryers are installed next to each other, they should be spaced 24 inches apart.
- 3) Place the installation template (provided) on the wall at a suitable mounting height and drill holes as per the template.
- 4) Fix screws (provided) in the wall. Keep the screw heads about 7-8 mm away from the wall.
- 5) With help of keyholes provided on the back plate of the hand dryer (Refer Fig. 1), hang the hand dryer on the wall.
- 6) Only use a **three pin 15 Amps socket** to supply power to the hand dryer for proper functioning of the hand dryer and safety of the users.
- 7) Make sure the wiring is compliant with the local building codes to safely support an appliance of this rated power. For rated power, please refer the label on the product or the technical specifications in the catalog.

6) After making the wire connections, please verify them again as wrong connections can cause short circuit and irreparable damage to the PCB. 

7) Fix the sensor connector into the PCB and fit the outer cover.

8) Switch ON the power supply.

9) Check if the hand dryer is working properly.

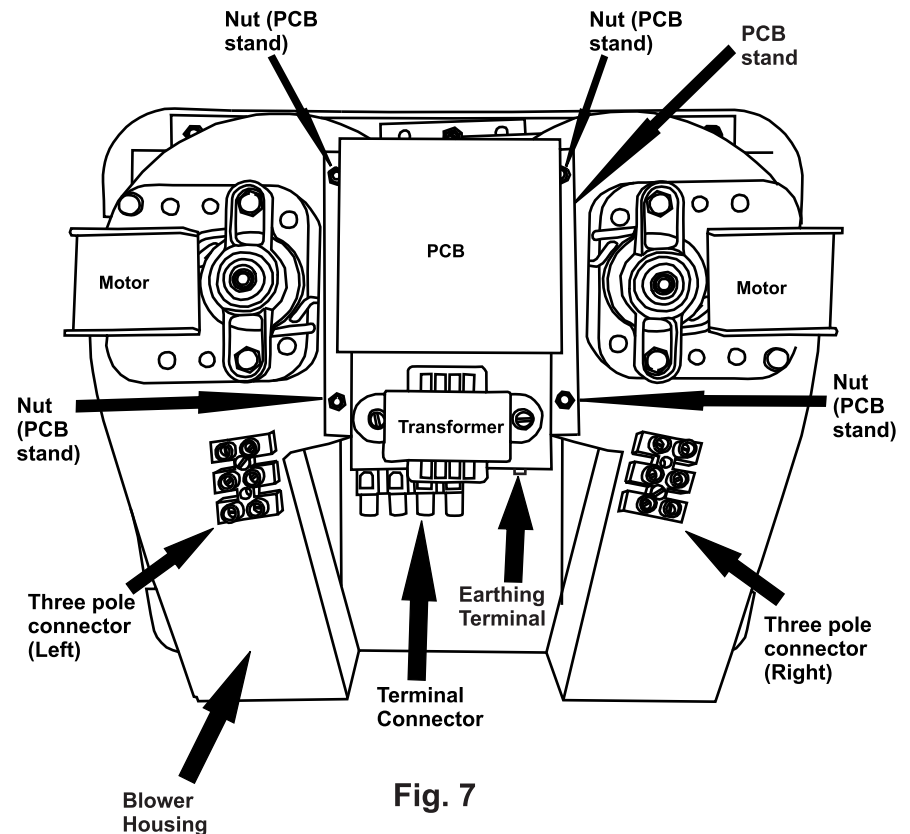

Fig. 7

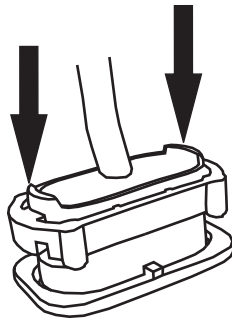

Fig. 6

How to replace the PCB (Printed Circuit Board):

- 1) Switch OFF the power supply and unplug the power supply cord. Remove the outer cover as described previously.
- 2) Once the outer cover is completely detached, remove the four wires (red, two black and yellow wires) that go to the terminal connector (Refer Fig. 7) on the 'A' side (Refer Fig. 8).
- 3) Remove the four nuts (Refer Fig. 7) that fit the PCB stand to the blower housing of the hand dryer.
- 4) Once the PCB along with its stand is detached, place the new PCB with the stand in its place and fasten the four nuts removed earlier.
- 5) Fit the four wires removed earlier on the 'A' side of the terminal connector in their correct positions. (Refer Fig. 8). The wire connections on the 'B' side of the terminal connector are already made by the manufacturer and need not be touched.
- 6) Fit the sensor connector to the PCB.
- 7) Fit the outer cover and install the hand dryer.

How to use the hand dryer:

- 1) Shake off excess water on the hands.
- 2) Place your hands below the sensor at a distance of 3-4 inches.
- 3) Rub your hands gently in the hot air till the hands are dry.

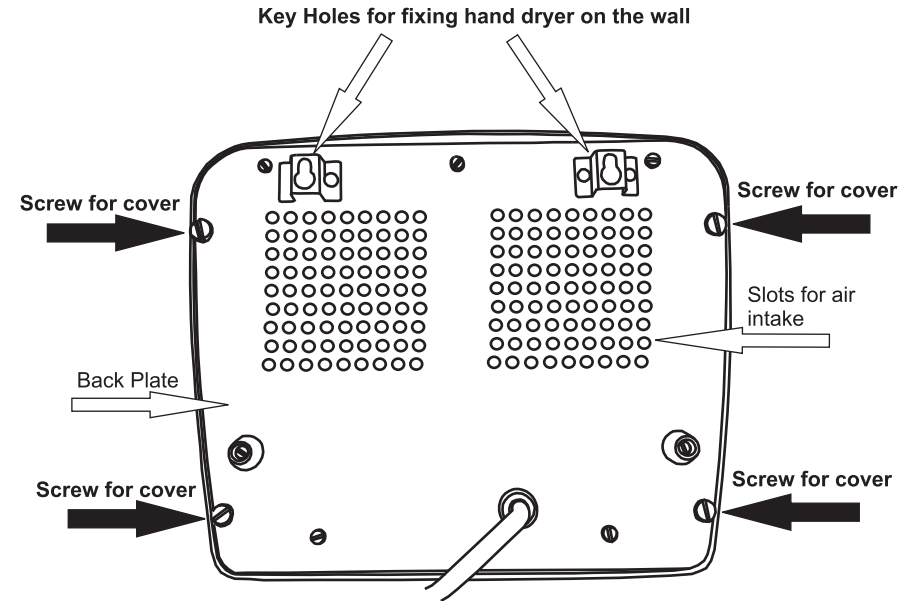

Fig.1

How to remove the hand dryer outer cover:

- 1) Switch off the power supply and unplug the power cord.
- 2) Remove the hand dryer from the wall and place it on a table with the back plate facing upwards as shown in Fig. 1.
- 3) Remove the four screws located at the back of the hand dryer as shown in above figure. Now turn the hand dryer over along with the outer cover such that the outer cover is facing upwards.
- 4) Gently lift the outer cover and unplug the connector which fits the sensor module to the PCB. The outer cover is now detached. The sensor module remains fitted to the outer cover.

Note: Please follow the step 4 of the procedure properly



How to replace the Sensor Module:

- 1) Follow the procedure mentioned under 'How to remove the hand dryer cover'.
- 2) The sensor module is fitted to the outer cover with a top ring and bottom ring as shown in Fig. 2
- 3) The sensor module has two notches as shown in Fig. 3
- 4) After the outer cover is completely detached, take a small flat head screw driver and put it between the top ring and sensor module as shown in the Fig. 4. Pull it up to dislodge the top ring from the sensor module. It is ok for the top ring to bend or twist during this process.
- 5) Once the top ring is removed, the sensor module will be completely detached from the outer cover. Replace the old sensor module with a new one. Push the sensor module from outside to hold it in its place while fixing it.
- 6) First put the bottom ring over the sensor module. Then fit the top ring in the top notch on one side and press it from the other side as shown in Fig. 5. The top ring will be locked in the top notches on both the sides of the sensor module.
- 7) Press the top ring once again on both sides as shown in Fig. 6 so that the top ring will be locked in the bottom notches and the sensor module will be firmly locked in its place.
- 8) Fit the sensor connector to the PCB.
- 9) Fit the outer cover and install the hand dryer.

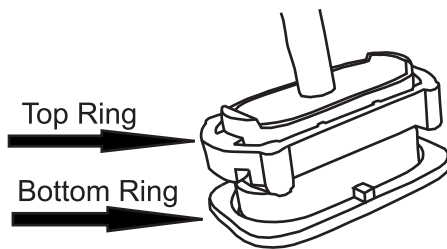

Fig. 2

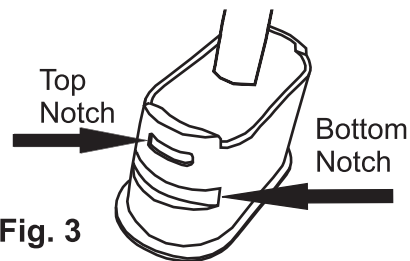

Fig. 3

Sensor Module

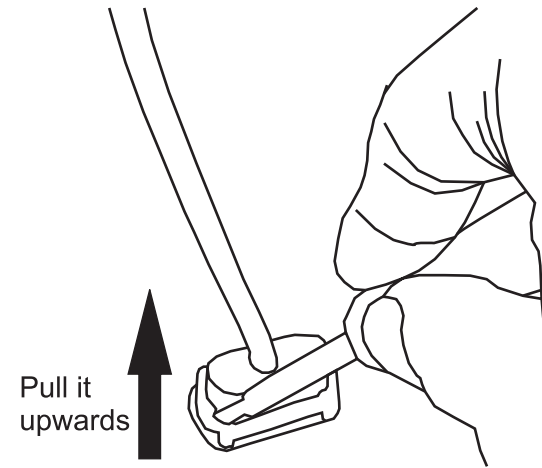

Fig. 4

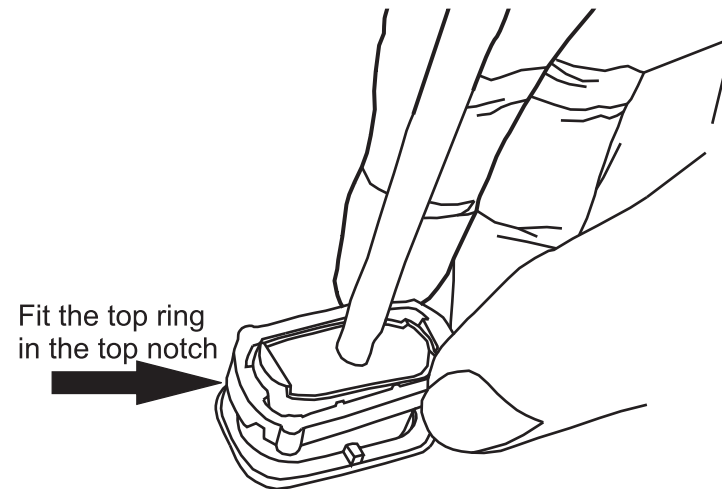

Fig. 5